

SIDE PLANKS AND FENDERS, 3/4" CL'R. WHT. PINE

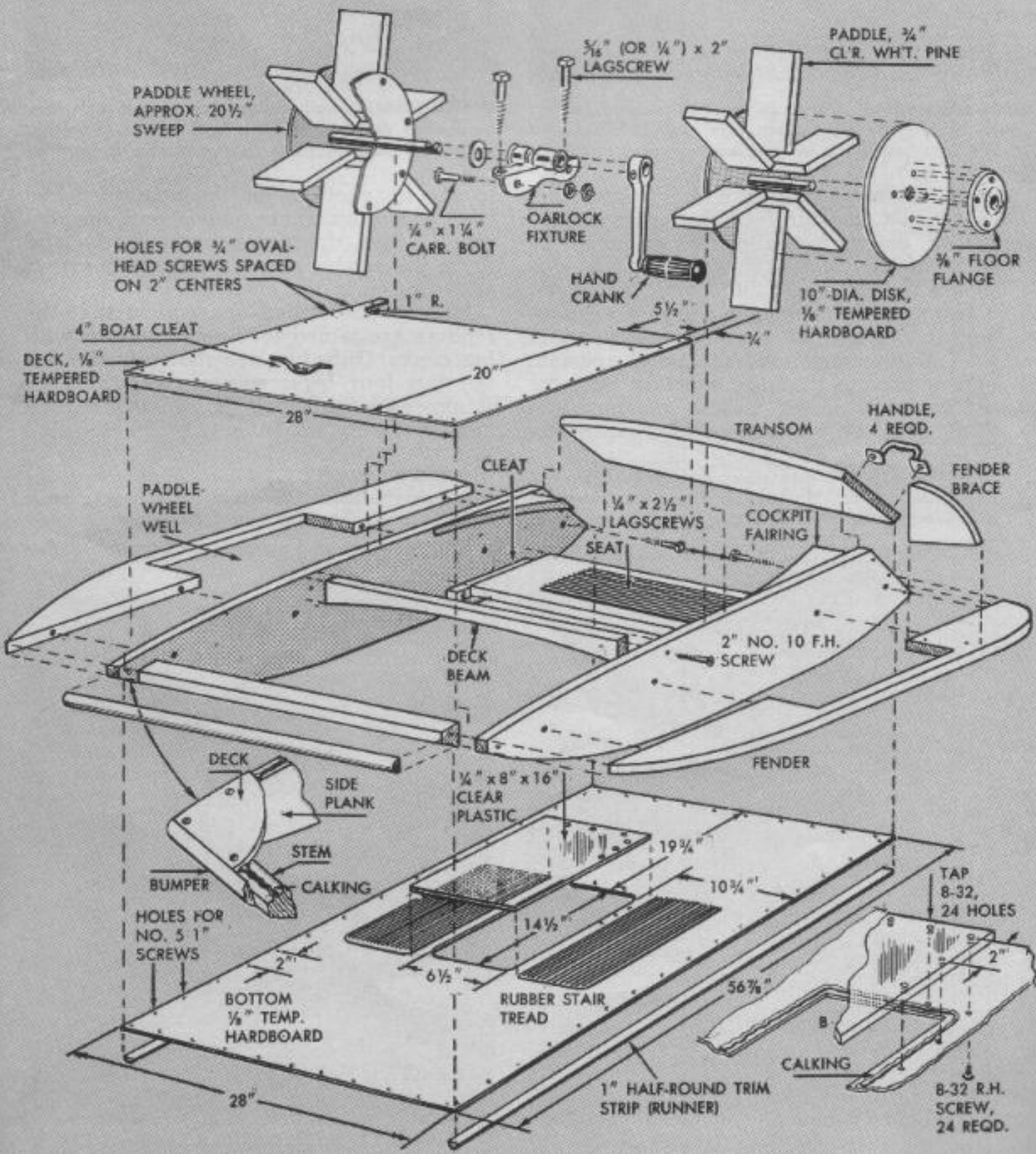

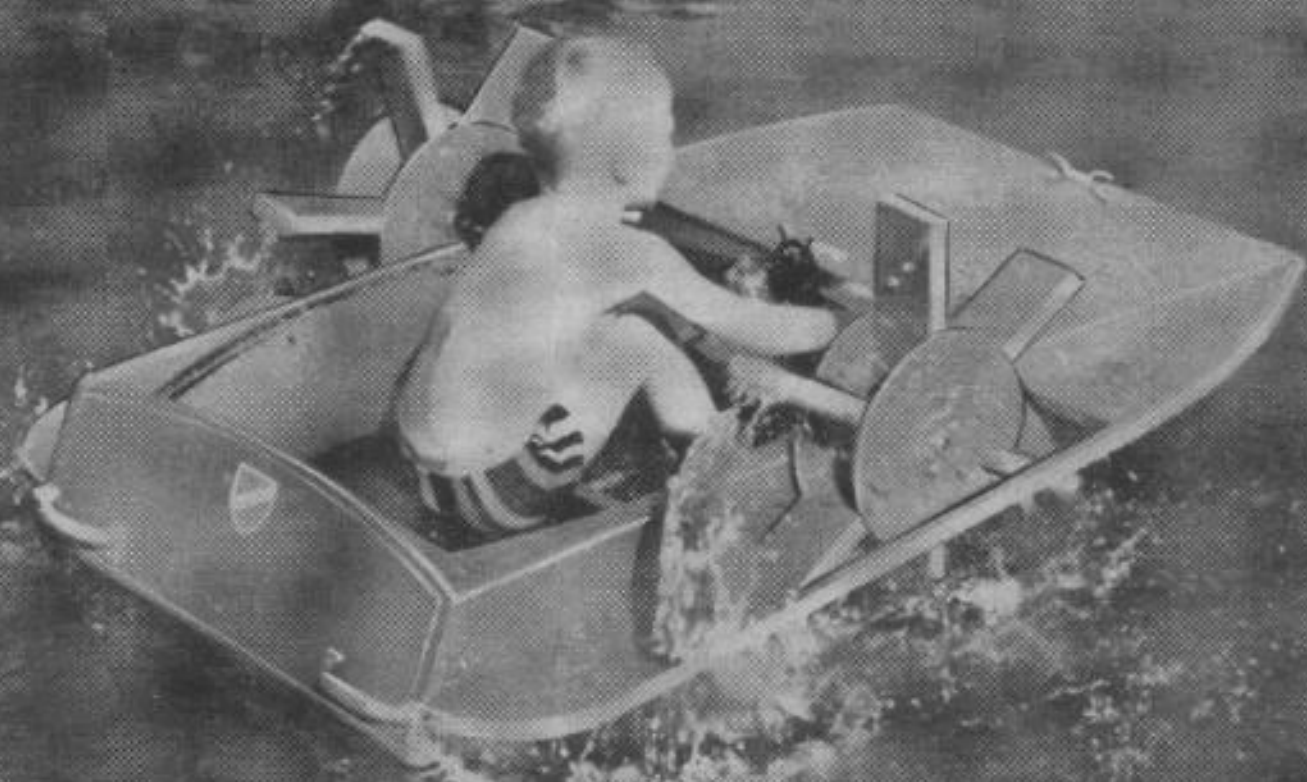

"WATERBUG"

By **W. Clyde Lammey**

SAFE AS ANY HULL afloat, *Waterbug* won't flip over frontwards, backwards or sideways. It can ride out a rough "sea" in a fair size pond, and it can be launched in any wading water that's over ankle deep. Just about every part needed except the bike-pedal cranks, handlebar grips and the oarlock fixtures that serve as bearings for the paddle wheels, are available from your local lumber and hardware dealers.

One good look at the details and you have a clear idea of the construction of *Waterbug*. Note at the outset that the original *Waterbug* was equipped with a "glass" bottom window for sub-surface study of marine life such as crawfish, chance salamanders, minnow schools and the like. It's made by cutting an opening in the bottom and screwing clear plastic over it in a bed of calking compound. Be sure to round any sharp edges with a file.

There are several points in the construction which should be noted before you cut

Designed by **Robert Woolson**

stock: First of all, the stem, or nosepiece, the deck beam, seat and transom should be cut to precisely the same length and square at the ends so that you get a true fit of the joints. The seat board can be cut about $\frac{1}{16}$ in. less for easier installation, if desired. The details at the top of the opposite page give the finished lengths of the side planks and fenders. When rough cutting to the patterns, saw these parts a trifle over, about $\frac{1}{8}$ in., so that you have stock left for fairing in to get a good fit of the bottom panel, the deck and transom at the joints. This is quite important as otherwise you may come up a trifle under especially when fairing the top and bottom edges of the side planks to obtain a true curve and a tight fit of the parts. The sectional size of the stem and deck beam is given in the details, and you plot the curves of the beam and transom from the cross-hatched detail on page 143.

Good waterproof bottom and deck joints were made in the original *Waterbug* sim-



DO A CAREFUL JOB of fairing in deck and bottom to assure water-tight joints. Even a slight offset at a joint may result in a leak. Be sure curves are uniform

ply by laying a bead of calking compound on one joining surface. The same water-proofer is used in the transom joints to the side planks. Such joints will not leak if the fit is true along the length. However, if you prefer you can use a dry-mix (powdered) waterproof resin glue instead of the calking compound. Again make certain before joining that the meeting surfaces are properly faired to give a true, tight joint. Mix the waterproof glue according

HANDLES ATTACHED to nosespiece forward and to sternboard aft provide for easy transport, launching and beaching of Waterbug. Use galvanized handles

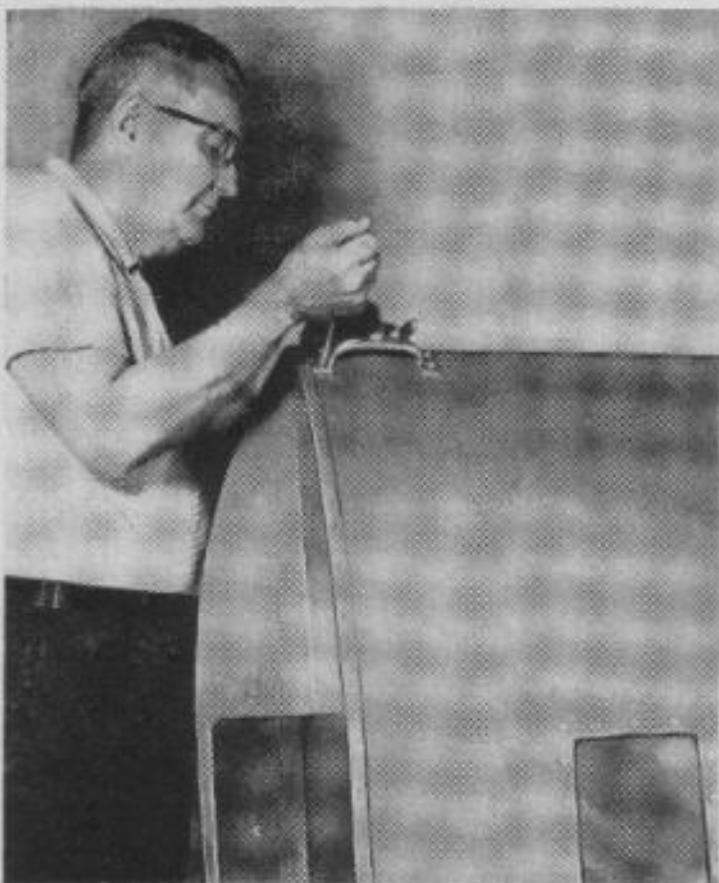

IF YOU PREFER, small machine screws with nuts may be used to draw up window tight in bed of calking instead of tapping holes in the plastic as detailed

to the instructions on the container and then coat both joining surfaces quite liberally. Join the parts immediately and drive the screws home, spacing the screws as indicated in the details.

Note in the pulled-apart view that the fenders are joined to the side planks with lagscrews. Only two are shown in the detail but four lagscrews are required for joining each fender, the holes being located approximately as indicated. The location

HARDWOOD BUMPER STRIP is attached to nosespiece with heavy screws. Top edge of bumper extends $\frac{1}{8}$ in. to form rabbet for seating forward end of deck

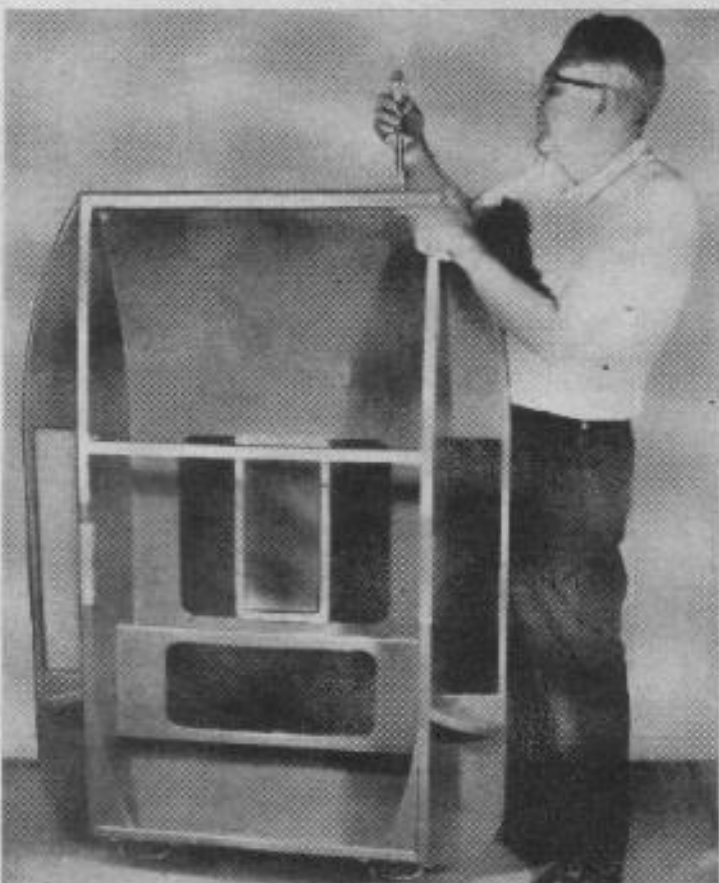

of each fender on the side plank is shown in the top detail, page 141. The bumper and runners should be made from hardwood such as oak, and attached with flat-head screws, the heads countersunk flush. Installing the cockpit fairing, the cockpit and fender trim and the four lift handles finishes the hull ready for the paddle wheels. These are duplicates, each having six paddles located on 60-degree centers. The paddles are cut from 1 x 4 stock and each set of six paddles is joined to two 10-in. disks of $\frac{1}{8}$ -in. tempered hardboard with waterproof glue and screws. Two points to watch when assembling the wheels are uniformity in width of the paddles and the spacing. Also, one must make sure of the projection of the paddles so that the outer ends describe a true circle when the wheel is turned. Your 1 x 4 from which the paddles are cut should be free from knots, straight-grained, and not cupped across the width.

Note that the paddle-wheel shaft has a flat filed near one end to take the draw pin which locks the bike pedal crank in place. The cranks are assembled with handles which turn. Each consists of a handlebar grip (bike replacement part), a carriage



CHECK FIT OF DECK before installing permanently. Make sure screw holes are uniformly spaced and that there are no skips in calking seal. Sand edges flush

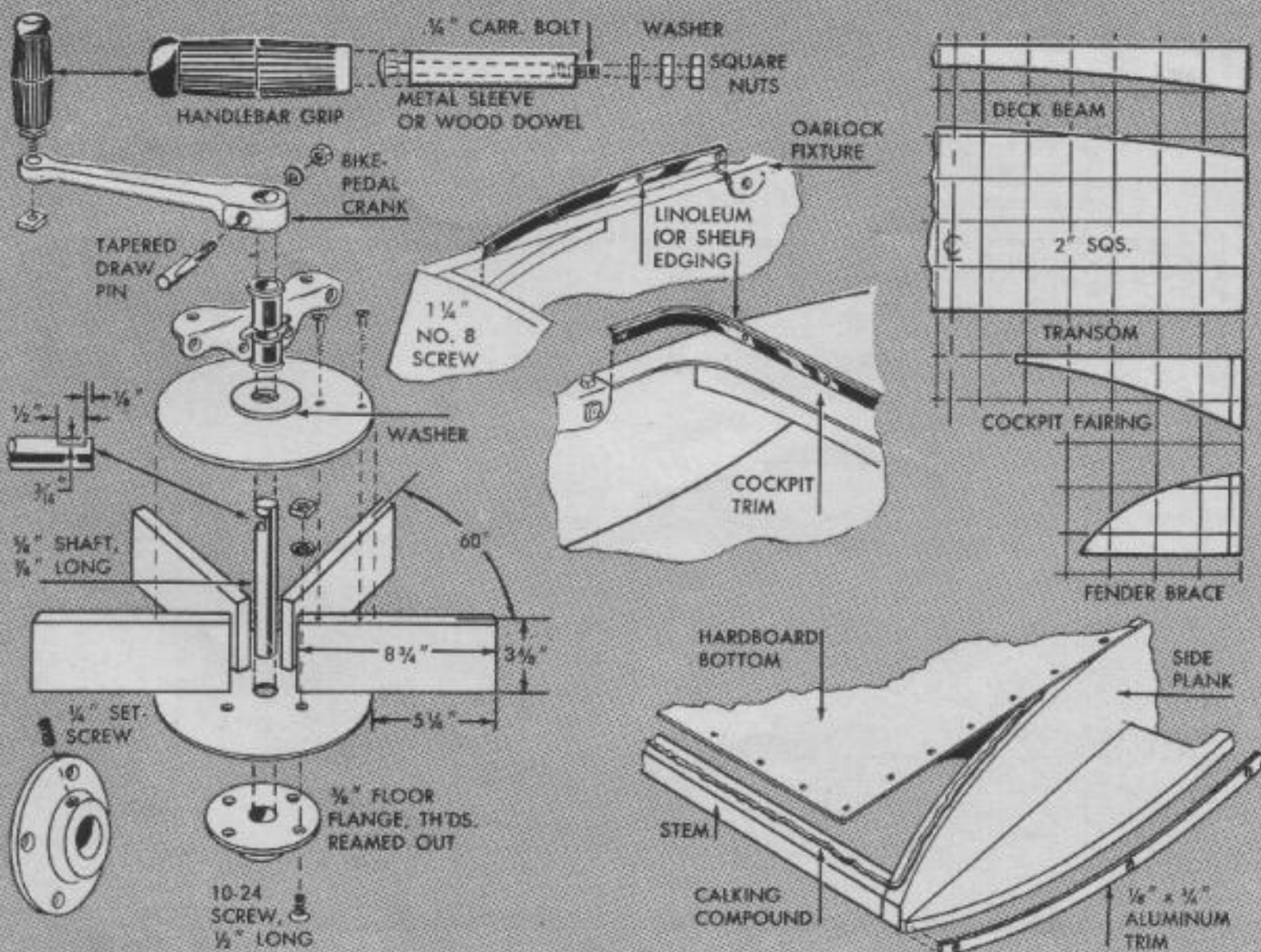

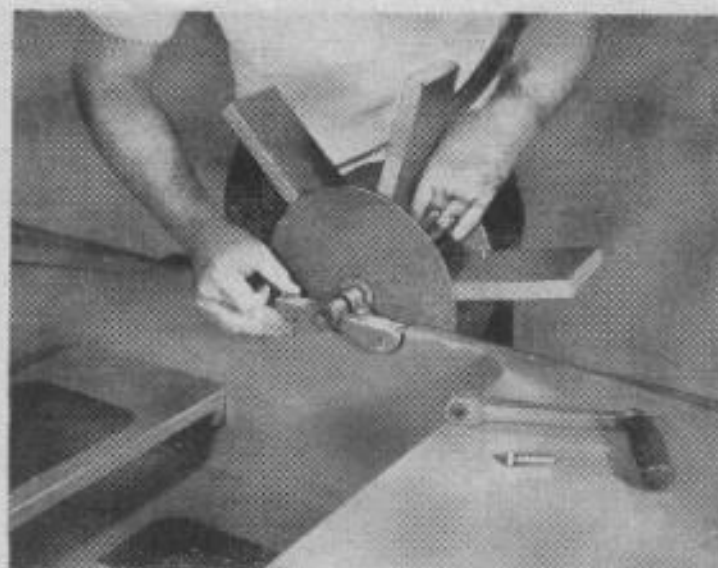

PADDLE-WHEEL SHAFT above, turns in bearing adapted from oarlock fixture. Latter attached with screws and bolts. Below, under some conditions water may be splashed inboard by paddle wheels. Install guard as detailed, screwing it to side planking

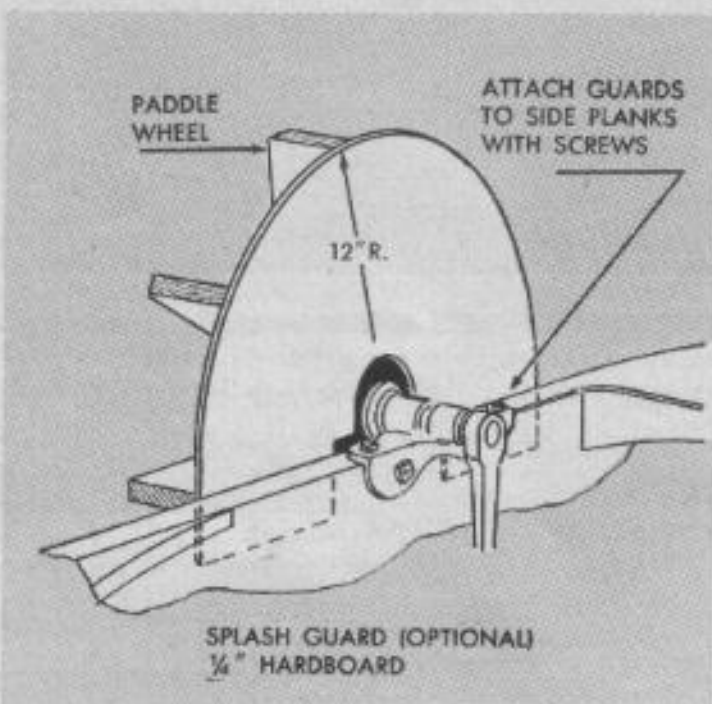

bolt, a metal sleeve—or a sleeve made by center-drilling a length of dowel—which fits tightly inside the handlebar grip, a washer and two square nuts. When assembled as indicated the grip should turn freely on the bolt but to achieve this you may have to grind off the squared section under the head of the bolt and also grind down the bolt head slightly to assure its turning freely inside the grip. When attaching to the crank (also a bike replacement part) you run one nut down on the threads over the washer, insert the threaded end of the bolt through the smaller hole in the crank, run on the second nut and tighten it.

Paddle-wheel bearings are oarlock fixtures adapted to the purpose. You will have to ream out the slightly tapered hole to take the $\frac{5}{8}$ -in.-diameter wheel shaft. The adapted bearings are attached to the side planks, each with two bolts and two lagscrews. The outer ends of the wheel shafts fit into $\frac{3}{8}$ -in. pipe flanges, the threads being reamed out to take the shaft ends in a snug, sliding fit. The hub of each flange is tapped for a hollow setscrew.

When the paddler is going all out in a breeze the paddle wheels may lift a little water into the bilge. This can be largely prevented by installing wheel guards as shown at the left. This feature is, of course, optional and there is one disadvantage: when there's wind, the guards can act as sails, may possibly make the boat less easy to control. ★★★

FENDERS ARE EDGED with aluminum rub strips. Use aluminum screws spaced about 6 in. apart. Rub strips extend full length of fender for maximum protection

